

SHAWSTON

www.shawston.co.uk

BlazeMaster® Fire Sprinkler Systems



Keeping the art of distribution simple

Keeping the art of Fire Protection simple

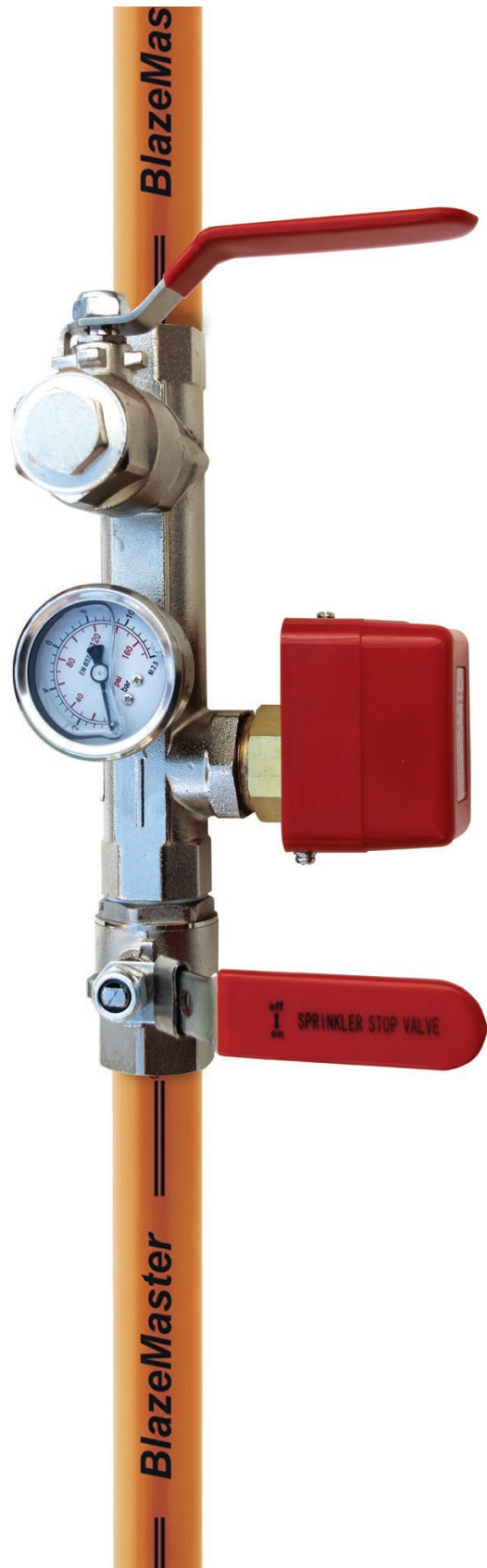

The demand for cost effective, high quality fire protection systems has risen dramatically over recent years. Recognising this growing demand alongside our dedication to provide unrivalled service, Shawston offer on an ex-stock basis a complete package for the Residential Sprinkler Market. **BlazeMaster CPVC Residential Sprinkler Pipe; Residential Test Valves; Brackets & Supports.**

ONE ORDER.

ONE COMPANY **ONE INVOICE.**

ONE DELIVERY.

Shawston are the only employee owned UK distributor with national depot coverage. Our **five depots** hold deep stocks to service the Fire Sprinkler and Dry/Wet Riser markets. We like to keep the art of distribution simple; one order, one delivery and one invoice.

Our large fleet of delivery vehicles means:

- We can offer next day delivery, nationwide.
- We can track all our vehicles in real time and make contact with every driver at any time.
- We can control arrival times to site to meet client driven time slots.
- We can provide unrivalled levels of customer service.

Keeping the art of Fire Protection simple

5 Reasons to Connect with Confidence



No more lost time spent procuring stock from different suppliers. We have the complete package at your disposal including: BlazeMaster CPVC, Residential Sprinkler Test Valves, Brackets & Supports.



Improved on-site productivity. The full delivery on one vehicle which means less offloading and less paperwork.



No stealth carriage or minimum orders. Our terms and conditions of sale are clear and transparent.



Unrivalled, hassle free, reliable service – always. We are an experienced market leading Fire Sprinkler, Dry/Wet Riser distributor. Our skilled in-house team are passionate about customer service day in, day out.



Run out of stock on site? Our trade counter is open to collect five days a week or next day delivery can be arranged from one of our five nationwide depots.



Blazemaster® CPVC Fittings

Pipes



CODE	DN		OD mm	ID mm	L m	Kg	
80300T	20	¾"	26.7	22.7	3.05	0.6	LPCB
80301T	25	1"	33.4	28.5	3.05	0.9	LPCB
80302T	32	1¼"	42.1	35.9	3.05	1.4	LPCB
80303T	40	1½"	48.3	41.1	3.05	1.8	LPCB
80304T	50	2"	60.3	51.4	3.05	2.9	LPCB
80305T	65	2½"	73.0	62.2	3.05	2.9	LPCB
80306T	80	3"	88.9	75.7	3.05	6.3	LPCB

Elbows 45°



- Elbows, 45° Slip x Slip / 45°

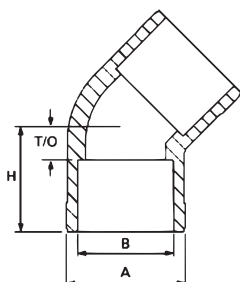

CODE	DN		A mm	H mm	T/O mm	Kg	
80050	20	¾"	33	30	9	0.036	LPCB
80051	25	1"	40	33	9	0.050	LPCB
80052	32	1¼"	50	47	20	0.091	LPCB
80053	40	1½"	59	48	12	0.141	LPCB
80054	50	2"	72	59	19	0.254	LPCB
80055	65	2½"	89	62	19	0.404	
80056	80	3"	106	75	25	0.504	

Blazemaster® CPVC Fittings

Elbows 90°



- **Elbows, 90° Slip x Slip / 90°**

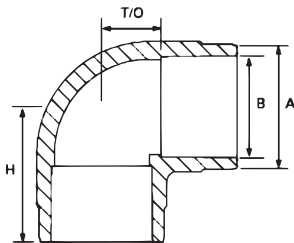

CODE	DN		A mm	H mm	T/O mm	Kg	
80025	20	¾"	33	36	16	0.041	LPCB FM UL VdS
80026	25	1"	40	43	19	0.063	LPCB FM UL VdS
80027	32	1¼"	50	50	23	0.095	LPCB FM UL VdS
80028	40	1½"	59	62	27	0.181	LPCB FM UL VdS
80029	50	2"	72	74	33	0.358	LPCB FM UL VdS
80030	65	2½"	87	85	39	0.517	FM UL
80031	80	3"	105	95	46	0.825	FM UL

Elbows 90° Reducing



- **Elbow Reducing, 90° Slip x Slip / 90°**

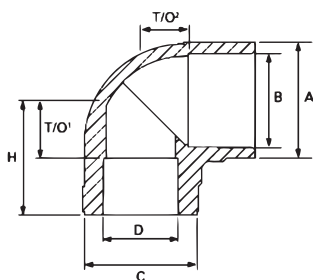

CODE	B DN		D DN		A mm	C mm	H mm	T/O¹ mm	T/O² mm	Kg	
80032	25	1"	20	¾"	40	40	41	1	17	0.073	LPCB FM UL VdS

Blazemaster® CPVC Fittings

Tee Equal



- Tee, Equal Slip x Slip x Slip

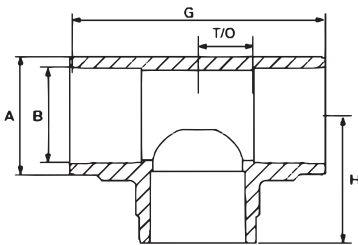

CODE	B DN		A mm	H mm	G mm	T/O mm	Kg	
80000	20	¾"	33	36	72	16	0.050	LPCB
80001	25	1"	40	40	81	18	0.086	LPCB
80002	32	1½"	50	48	95	22	0.118	LPCB
80003	40	1½"	59	62	125	27	0.231	LPCB
80004	50	2"	72	75	150	36	0.408	LPCB
80005	65	2½"	87	86	171	39	0.721	
80006A	80	3"	105	95	191	46	1.093	

Cross Equal



- Cross, Equal Slip x Slip x Slip

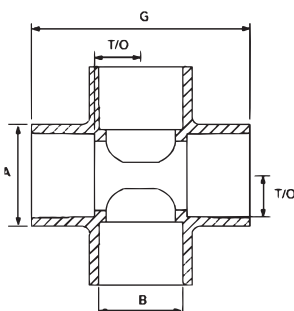

CODE	B DN		A mm	G mm	T/O mm	Kg	
80009	20	¾"	33	70	15	0.059	LPCB
80010	25	1"	40	84	18	0.104	LPCB
80011A	32	1½"	50	95	23	0.154	LPCB
80012	40	1½"	59	125	27	0.304	LPCB
80013	50	2"	72	145	33	0.454	LPCB
80014A	65	2½"	89	171	39	0.866	LPCB
80008A	80	3"	106	192	46	1.311	

Blazemaster® CPVC Fittings

Cross Reducing



CODE	B DN		D DN		A mm	C mm	G mm	H mm	T/O ¹ mm	T/O ² mm	Kg			
80015A	25	1"	20	¾"	40	40	84	42	18	22	0.127	FM	UL	VdS

- Cross Reducing, Slip x Slip x Slip x Slip

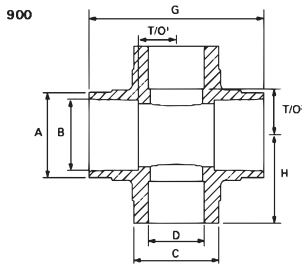

Coupling Equal



- Coupling Equal, Slip x Slip

CODE	B DN		A mm	G mm	T/O mm	Kg				
80075	20	¾"	33	54	3	0.032	LPCB	FM	UL	VdS
80076	25	1"	40	64	3	0.050	LPCB	FM	UL	VdS
80077	32	1¼"	50	56	4	0.054	LPCB	FM	UL	VdS
80078	40	1½"	59	78	5	0.113	LPCB	FM	UL	VdS
80079	50	2"	72	84	5	0.172	LPCB	FM	UL	VdS
80080	65	2½"	87	98	6	0.304	LPCB	FM	UL	
80081	80	3"	105	108	5	0.413	FM	UL		

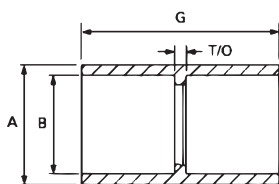

Blazemaster® CPVC Fittings

Coupling Reducing



CODE	B DN		D DN		A mm	C mm	G mm	H mm	T/O mm	Kg				
80220	25	1"	20	¾"	41	34	46	19	3	0.036	LPCB	FM	UL	VdS

- Coupling Reducing, Slip x Slip

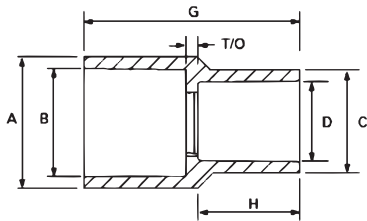

End Cap Slip



CODE	B DN		A mm	G mm	T/O mm	Kg				
80100	20	¾"	33	28	7	0.018	LPCB	FM	UL	VdS
80101	25	1"	40	33	10	0.027	LPCB	FM	UL	VdS
80102	32	1¼"	50	45	10	0.045	LPCB	FM	UL	VdS
80103	40	1½"	59	56	18	0.091	LPCB	FM	UL	VdS
80104	50	2"	72	57	15	0.141	LPCB	FM	UL	VdS
80105	65	2½"	87	70	22	0.263	LPCB	FM	UL	
80106	80	3"	105	76	24	0.400	LPCB	FM	UL	

- End Cap, Slip

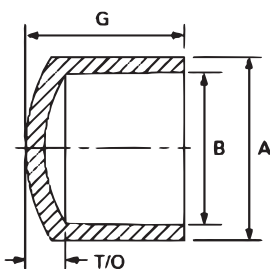

Blazemaster® CPVC Fittings

Tee Reducing

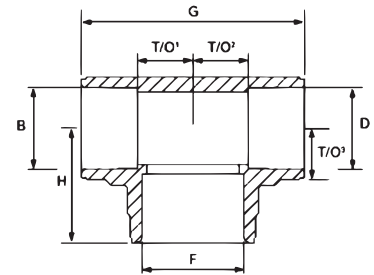

- Tee, Reducing, Slip x Slip x Slip

CODE	Tee Size B x F x D			Tee Size B x F x D			G mm	H mm	T/O¹ mm	T/O² mm	T/O³ mm	Kg	LPCB
	DN	DN	DN										
80132	20	25	20	¾"	1"	¾"	73	38	18	18	15	0.063	LPCB
80133	25	20	20	1"	¾"	¾"	71	38	15	15	19	0.063	LPCB
80134	25	25	20	1"	1"	¾"	78	41	19	18	18	0.077	LPCB
80260	25	20	25	1"	¾"	1"	79	40	15	15	20	0.073	LPCB
80135	32	20	25	1¼"	¾"	1"	85	43	16	15	24	0.095	LPCB
80136	32	25	25	1¼"	1"	1"	84	45	19	19	23	0.100	LPCB
80137	32	32	25	1¼"	1¼"	1"	92	46	23	23	22	0.118	LPCB
80261	32	20	32	1¼"	¾"	1¼"	82	43	16	16	23	0.104	LPCB
80262	32	25	32	1¼"	1"	1¼"	89	46	19	19	23	0.118	LPCB
80138	32	40	32	1¼"	1½"	1¼"	119	63	26	26	26	0.195	LPCB
80140	40	20	32	1½"	¾"	1¼"	100	53	15	15	26	0.163	LPCB
80141	40	25	32	1½"	1"	1¼"	100	57	15	15	27	0.172	LPCB
80263	40	20	40	1½"	¾"	1½"	103	53	15	15	24	0.163	LPCB
80264	40	25	40	1½"	1"	1½"	103	58	15	15	27	0.172	LPCB
80275	40	32	40	1½"	1¼"	1½"	118	59	22	22	26	0.204	LPCB

Blazemaster® CPVC Fittings

Tee Reducing (continued)

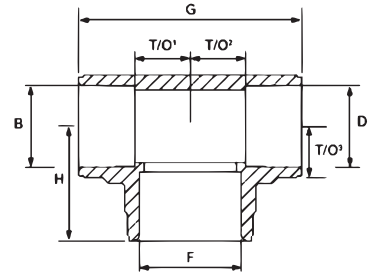

- Tee, Reducing, Slip x Slip x Slip

CODE	Tee Size B x F x D			Tee Size B x F x D			G mm	H mm	T/O¹ mm	T/O² mm	T/O³ mm	Kg	
	DN	DN	DN										
80265	50	20	50	2"	¾"	2"	116	62	19	19	35	0.277	LPCB FM UL VdS
80266	50	25	50	2"	1"	2"	123	66	22	22	35	0.299	LPCB FM UL VdS
80274	50	32	50	2"	1¼"	2"	132	69	26	26	36	0.336	LPCB FM UL VdS
80267	50	40	50	2"	1½"	2"	137	71	29	29	35	0.354	LPCB FM UL VdS
80271	65	25	65	2½"	1"	2½"	171	70	39	39	39	0.649	LPCB FM UL
80272	65	32	65	2½"	1¼"	2½"	171	73	39	39	40	0.662	LPCB FM UL
80273	65	40	65	2½"	1½"	2½"	171	75	39	39	39	0.671	LPCB FM UL
80276	65	50	65	2½"	2"	2½"	171	80	39	39	40	0.680	LPCB FM UL
80270	80	40	80	3"	1½"	2"	191	83	46	46	46	1.034	FM UL
80268	80	50	80	3"	2"	2"	191	85	46	46	46	1.021	FM UL
80269	80	65	65	3"	2½"	3"	191	92	46	46	46	1.107	FM UL

Blazemaster® CPVC Fittings

Bush Reducing



• **Bush Reducing, Spigot x Slip**

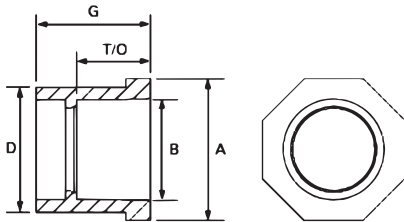

CODE	Size D x B		Size D x B		A mm	G mm	T/O mm	Kg	LPCB VdS
	DN	DN							
80200	25	20	1"	¾"	38	30	11	0.018	LPCB VdS
80201	32	20	1¼"	¾"	47	32	12	0.050	LPCB VdS
80202	32	25	1¼"	1"	47	32	8	0.054	LPCB VdS
80203	40	20	1½"	¾"	53	42	15	0.072	LPCB VdS
80204	40	25	1½"	1"	53	42	12	0.063	LPCB VdS
80205	40	32	1½"	1¼"	53	42	9	0.077	LPCB VdS
80206	50	20	2"	¾"	66	47	20	0.122	LPCB VdS
80207	50	25	2"	1"	66	47	17	0.118	LPCB VdS
80208	50	32	2"	1¼"	66	47	14	0.109	LPCB VdS
80209	50	40	2"	1½"	66	47	11	0.086	LPCB VdS
80215	65	25	2½"	1"	79	54	24	0.190	LPCB
80214	65	32	2½"	1¼"	79	54	20	0.204	LPCB
80213	65	40	2½"	1½"	79	54	18	0.209	LPCB
80211	65	50	2½"	2"	79	54	15	0.152	LPCB
80210	80	50	3"	2"	96	59	20	0.387	
80212	80	65	3"	2½"	96	59	13	0.213	

Blazemaster® CPVC Fittings

Coupling Adapter



- Coupling Adapter, Slip x Groove

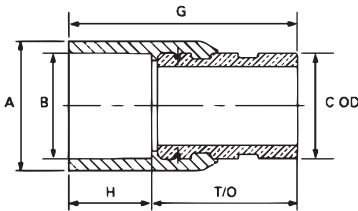

CODE	Size				A mm	G mm	H mm	T/O mm	Kg	
	Nom.		B mm	C mm						
	DN									
80160	32	1¼"	32	42.2	52	93	34	59	0.354	LPCB FM UL VdS
80161	40	1½"	40	48.3	59	95	37	58	0.431	LPCB FM UL VdS
80162	50	2"	50	60.3	72	98	40	58	0.644	LPCB FM UL VdS
80163	65	2½"	65	73.0	87	107	49	58	1.034	LPCB FM UL
80169	65	2½"	65	76.1	91	107	49	58	1.155	LPCB FM UL
80164	80	3"	80	88.9	105	110	52	58	1.361	FM UL

Threaded Adapter



- Male Threaded Adapter, Slip x Male Thread

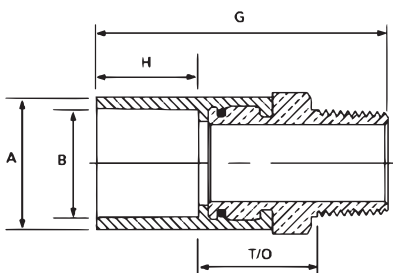

CODE	B Nom.		B Threaded		A mm	G mm	H mm	T/O mm	Kg	
	DN		DN							
80157	20	¾"	20	¾" NPT	33	72	25	33	0.150	LPCB FM UL VdS
80158	25	1"	25	1" NPT	40	84	32	35	0.254	LPCB FM UL VdS
82005	25	1"	25	1" BSP	40	84	32	35	0.254	LPCB FM UL VdS

Blazemaster® CPVC Fittings

Threaded Adapter



- Female Threaded Adapter, Slip x Female thread

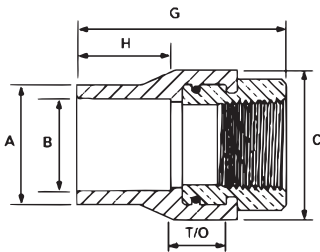

CODE	B Nom.		B Threaded		A mm	C mm	G mm	H mm	T/O mm	Kg	LPCB	FM	UL	VdS
	DN		DN											
80142	20	3/4"	20	3/4" NPT	35	43	61	27	21	0.186	LPCB	FM	UL	VdS
80145	25	1"	25	1" NPT	43	52	69	30	23	0.286	LPCB	FM	UL	VdS
80146	32	1 1/4"	32	1 1/4" NPT	52	61	79	34	28	0.467	LPCB	FM	UL	VdS
80147	40	1 1/2"	40	1 1/2" NPT	59	67	87	36	34	0.644	LPCB	FM	UL	VdS
80148	50	2"	50	2" NPT	72	88	100	40	43	1.207	LPCB	FM	UL	VdS
82001	25	1"	25	1" BSP	43	52	69	30	23	0.286	LPCB	FM	UL	VdS
82002	32	1 1/4"	32	1 1/4" BSP	52	61	79	34	28	0.467	LPCB	FM	UL	VdS
82003	40	1 1/2"	40	1 1/2" BSP	59	67	87	36	34	0.644	LPCB	FM	UL	VdS
82004	50	2"	50	2" BSP	72	88	100	40	43	1.207	LPCB	FM	UL	VdS

Sprinkler Head Adapter Type E



- Female Threaded Adapter, Slip x Female Thread, Type E

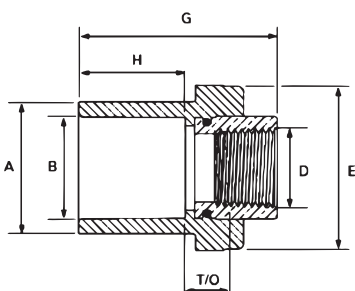

CODE	B		D		A mm	C mm	G mm	H mm	T/O mm	Kg	LPCB	FM	UL	VdS
	DN		DN											
80175E	20	3/4"	15	1/2" NPT	35	43	52	28	12	0.091	LPCB	FM	UL	VdS
80176E	25	1"	15	1/2" NPT	43	43	56	31	12	0.100	LPCB	FM	UL	VdS

Blazemaster® CPVC Fittings

Sprinkler Head Adapter



CODE	B		D		A mm	G mm	H mm	T/O mm	Kg	LPCB	FM	UL	VdS
	DN		DN										
80175W	20	3/4"	15	1/2"	41	44	19	12	0.086	LPCB	FM	UL	VdS
80176W	25	1"	15	1/2"	40	49	25	12	0.082	LPCB	FM	UL	VdS

- Female Threaded Adapter, Slip x Female Thread, Type W

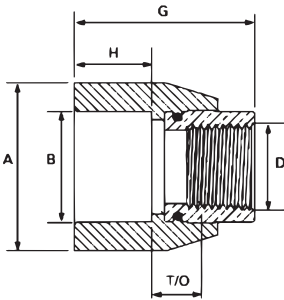

Sprinkler Head Adapter



CODE	B		D		A mm	C mm	G mm	H mm	T/O mm	Kg	LPCB	FM	UL	VdS
	DN		DN											
80175WL	20	3/4"	15	1/2" NPT	33	33	44	20	11	0.073	LPCB	FM	UL	VdS
80179	25	1"	20	3/4" NPT	43	43	64	30	11	0.195	LPCB	FM	UL	VdS

- Female Threaded Adapter, Slip x Female Thread, Type WL

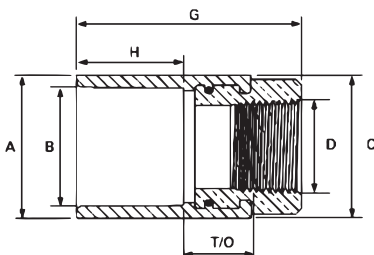

Blazemaster® CPVC Fittings

Sprinkler Head Adapter



CODE	B		D		C mm	G mm	H mm	T/O mm	Kg	LPCB
	DN		DN							
80177L	20	¾"	15	½" NPT	34	45	19	13	0.073	LPCB
80178	25	1"	15	½" NPT	43	49	22	14	0.091	LPCB
80180	25	1"	20	¾" NPT	43	57	22	22	0.180	LPCB

- Sprinkler Head Adapter, Spigot x Female Thread

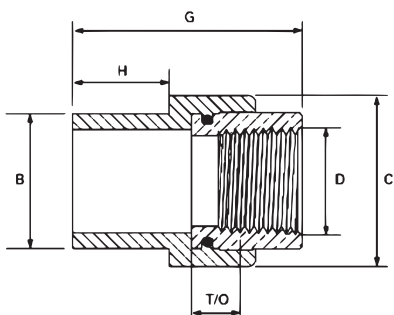

Blazemaster® CPVC Fittings

Sprinkler Head Tee

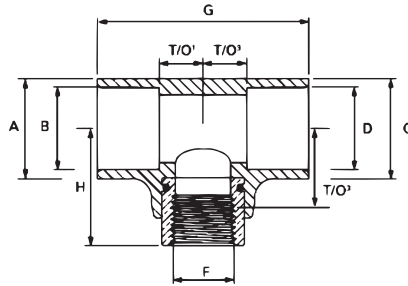

- **Sprinkler Head Tee, Slip x Female Thread x Slip**

CODE	B x F x D						A mm	C mm	G mm	H mm	T/O¹ mm	T/O² mm	T/O³ mm	Kg	
	DN		DN		DN										
80250	20	¾"	15	½" NPT	20	¾"	33	33	69	38	14	14	25	0.100	
80251	25	1"	15	½" NPT	25	1"	40	40	83	46	18	18	36	0.131	
80252	32	1¼"	15	½" NPT	32	1¼"	50	50	76	46	11	11	33	0.141	
80256	32	1¼"	15	½" NPT	25	1"	50	40	76	46	11	14	33	0.136	
80249	25	1"	25	1" NPT	25	1"	40	40	93	56	23	23	40	0.331	
80257	40	1½"	15	½" NPT	32	1¼"	59	52	98	49	12	12	36	0.195	
80254	40	1½"	15	½" NPT	40	1½"	59	59	98	49	12	12	36	0.209	
80258	50	2"	15	½" NPT	40	1½"	72	59	104	55	12	12	43	0.254	
80253	50	2"	15	½" NPT	50	2"	72	72	104	55	13	13	42	0.281	

Blazemaster® CPVC Fittings

Sprinkler Head Adapter



CODE	B		D		A mm	G mm	H mm	T/O ¹ mm	T/O ² mm	Kg	
	DN		DN								
80199	20	¾"	15	½" NPT	33	35	38	14	25	0.091	LPCB
80198	25	1"	15	½" NPT	40	40	44	18	31	0.118	LPCB
80196	25	1"	20	¾" NPT	45	51	49	27	37	0.120	LPCB

- Sprinkler Head Adapter, Spigot x Female Thread / Blazemaster Fitting

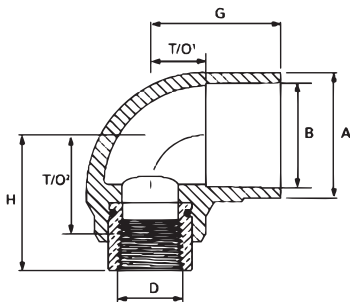

Back-To-Back Sprinkler Tee



CODE	B		D		A mm	G mm	H mm	T/O ¹ mm	T/O ² mm	Kg	Dry Wall Size	
	DN		DN									
80459	25	1"	15	½" NPT	40	92	47	34	17	0.218	¾"	LPCB
80460	25	1"	15	½" NPT	40	85	47	30	17	0.209	½"	LPCB

- Back-to-Back, Sprinkler Tee, Slip x Female Thread

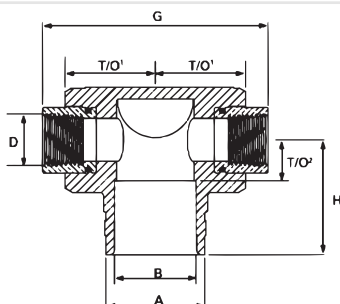

Blazemaster® CPVC Fittings

Back-To-Back Sprinkler Cross



CODE	B		D		A mm	G mm	H mm	T/O ¹ mm	T/O ² mm	Kg	Dry Wall Size	
	DN		DN									
80462	25	1"	15	½"	40	86	45.5	30	15	0.209	½"	LPCB
80463	25	1"	15	½"	40	93	45.5	34	15	0.213	¾"	LPCB

- Back-to-Back, Sprinkler Cross, Slip x Female Thread

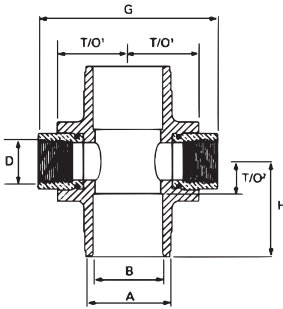

TFP-500



CODE	Packing Size	Description	Kg	
90740	0.47 Ltr, Tin/Dose/Pot	TFP-500 One-Step Cement with Dauber Attached to Lid	0.55	LPCB
90741	0.95 Ltr, Tin/Dose/Pot	TFP-500 One-Step Cement with Dauber Attached to Lid	1.08	LPCB

Blazemaster® CPVC Fittings

Dauber



CODE	Description	Kg
90400	Dauber 1½" Diameter for Pipe Sizes 1" to 3"	0.011
90401	Dauber ¾" Diameter for Pipe Sizes ¾" to 1¼"	0.008

TC3QPVC - CPVC Tools, Pipe Cutter



CODE	Description	Kg
90353	Pipe Cutter Model TC3 QPVC with Wheel for CPVC Pipe, Diameters DN20 to DN80	1.1
3-6PVC	Replacement Cutter Wheel Model 3-6PVC for Model TC3QPVC Pipe Cutter	0.32

DEB2 - Deburring Tool



CODE	Description	Kg
91346	Deburring Tool for Inner and Outer Edges of Pipes, for Pipe sizes upto DN50	1.1

DEB4 - Deburring Tool



CODE	Description	Kg
90357	Deburring Tool for Inner and Outer Edges of Pipes, for Pipe Sizes DN32 upto DN80	0.01

Blazemaster® CPVC Fittings

Test Plugs



CODE	A		Description	Color	Kg
	DN				
90270	15	½"	Test Plug, Brass Thread ½" for Sprinkler Fittings	White	0.115

Caulk & Walk® Fire Stopping Sealant



CODE	Packing Size	Description	Kg	
61126	0.3 Ltr Tube	Caulk & Walk Fire Stopping Sealant	0.4	UL

Glycerine U.S.P Grade



CODE	Packing Size	Description	Kg
90505	5 Ltr	Litre Can Antifreeze for CPVC Systems, USP Grade [96.5%]	0.4

Thread Sealant



CODE	Packing Size	Description	Kg
31232	0.47 Ltr	Joint Compound for CPVC Threaded Adapters	0.55

Blazemaster® CPVC Fittings

Rapid Seal Adapter



CODE	Description	Nominal Pipe Size ANSI Inches DN	Thread Size
80175RS2	Rapid Seal Straight Adapter	¾" DN20	½" NPS
80176RS2	Rapid Seal Straight Adapter	1" DN25	½" NPS
80177RS2	Rapid Seal Spigot	¾" DN20	½" NPS
80178RS2	Rapid Seal Spigot	1" DN25	½" NPS
80199RS2	Rapid Seal 90° Elbow	¾" DN20	½" NPS
80198RS2	Rapid Seal 90° Elbow	1" DN25	½" NPS

Gasket Replacement Tools

CODE	Description
3060	Rapid Seal Gasket Replacement Tool
3061	Rapid Seal Gasket Removal Pick
3062	Rapid Seal Replacement Gasket (Qty. 10)

Rapid Seal Tee



CODE	Description	Size
80250RS2	Sprinkler Head Tee Slip x Female	¾" x ½" x ¾"
80251RS2	Sprinkler Head Tee Slip x Female	1" x ½" x 1"
80460RS2	RSA Back-to-Back Sprinkler Tee (Slip x Female) NPT Thread	1" x ½" x ½" (3-3/8" takeout)
80459RS2	RSA Back-to-Back Sprinkler Tee (Slip x Female) NPT Thread	1" x ½" x ½" (3-5/8" takeout)

Rapid Seal Cross



CODE	Description	Size
80462RS2	RSA Back-to-Back Sprinkler Cross (Slip x Female) NPT Thread	1" x ½" x 1 x ½" (3-3/8" takeout)
80463RS2	RSA Back-to-Back Sprinkler Cross (Slip x Female) NPT Thread	1" x ½" x 1 x ½" (3-5/8" takeout)

Shawston offer a full range of fixings and pipe supports to install CPVC systems, this can be found in our [Pipe Supports and Bracketry brochure](#).

www.shawston.co.uk

Shawston London
Units 8 & 9,
Hillbottom Road,
Sands Industrial Estate,
High Wycombe,
Bucks HP12 4HS

Tel: 01494 460 910
Fax: 01494 522 573
Email: London@shawston.co.uk

Shawston Birmingham
Bay 1, Block D,
The Bescot Estate,
Woden Road West, Wednesbury
West Midlands WS10 7SG

Tel: 0121 556 3400
Fax: 0121 506 4669
Email: Birmingham@shawston.co.uk

Shawston Manchester
Great Norbury Street,
Hyde,
Cheshire SK14 1BW

Tel: 0161 368 4545
Fax: 0161 367 8114
Email: Manchester@shawston.co.uk

Shawston Glasgow
Block 1 Unit 4,
Annick Industrial Estate,
31 Sandilands Street,
Shettleston,
Glasgow G32 OHT

Tel: 0141 778 6975
Fax: 0141 778 6264
Email: Glasgow@shawston.co.uk
