

Sikla Framo

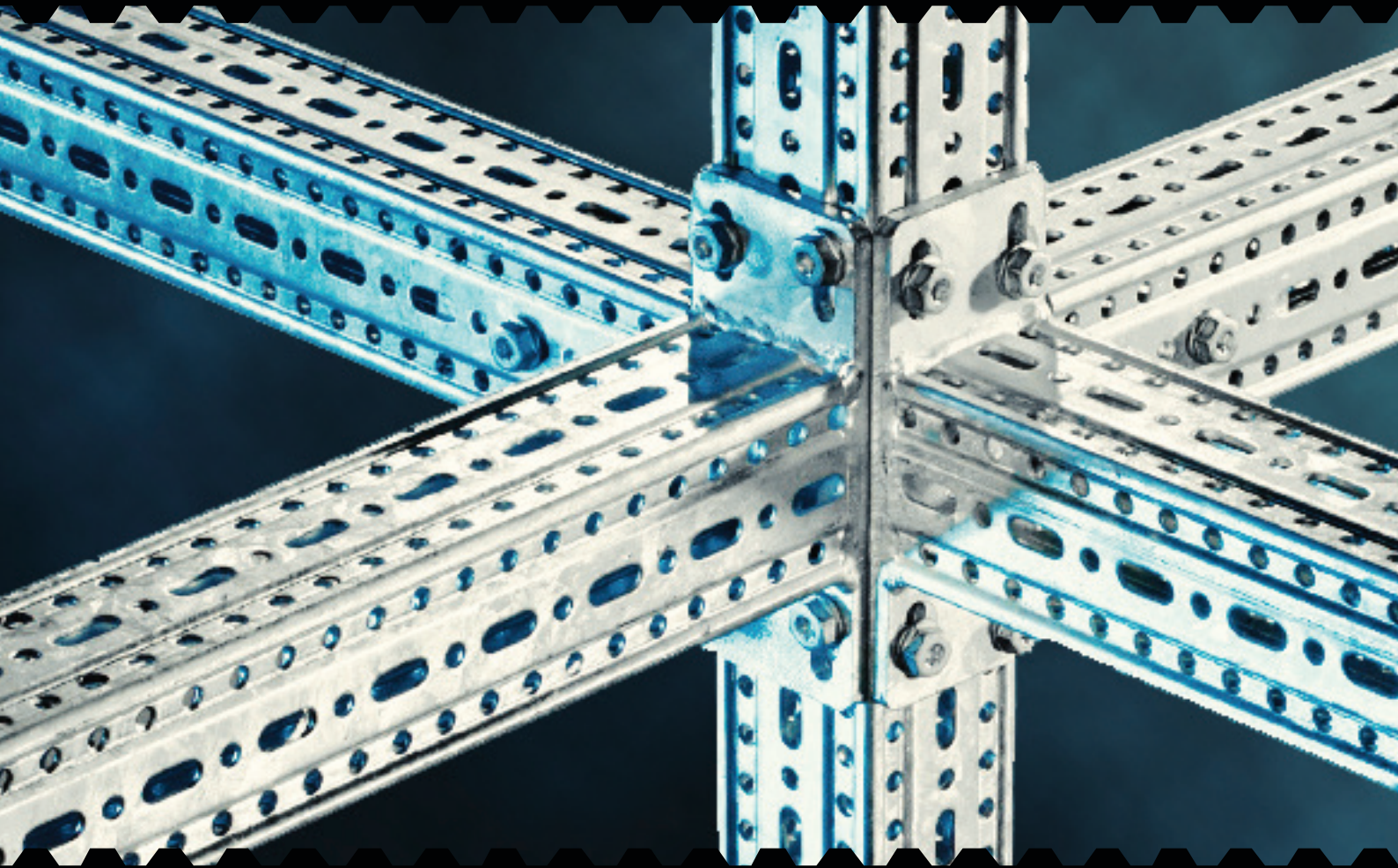

Keeping the art of distribution simple

Sikla Framo

Shaping the way in which pipework is installed.

Shawston are widely recognised as the UK's leading supplier of mechanical services products. The only UK supplier operating from 5 nationwide depots.

The complete Sikla Framo Modular Framing System is now available on an ex-stock basis. Lightweight, at only 5.1kg/m, Sikla Framo is easily adjustable with secured connections and takes minimal assembly due to the use of thread forming and shake proof fastenings.

Our unrivalled service means that we can deliver products on one order with one delivery note. Our in-house design team are equipped to offer technical support and advice based on upwards of 50 years' experience within the Mechanical Services industry.

With controlled arrival times to site, you can track your delivery which in turn allows you to meet and manage client deadlines stress free.

Box clever with Silka Framo.

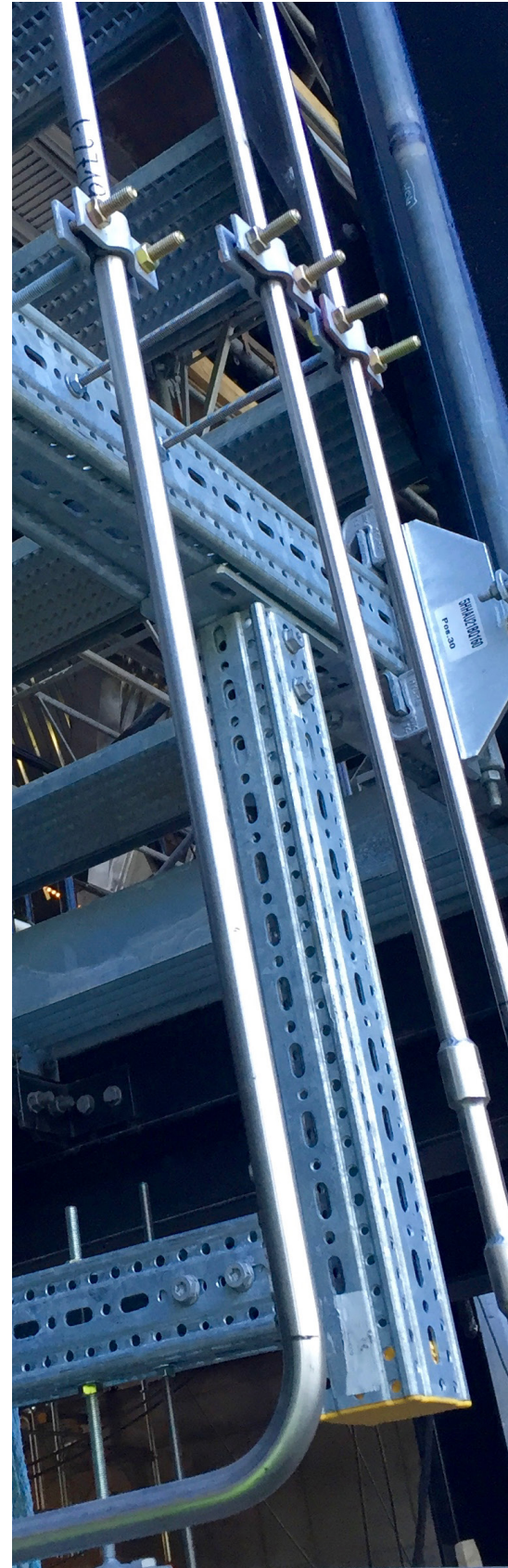

Sikla Framo

Meccano for grown-ups.

With over 50 years' experience in developing innovative products for above ground industrial pipe work installations, Sikla Framo is as easy as Mecanno.

- Strong but lightweight - Sikla Framo lessens the steel tonnage required on each project
- Entirely reusable thus cutting down wastage on site
- All siFramo 80 and 100 products are fully compatible with engineered hangers and supports
- No need for hot works on site
- Reduces the on site installation time for ME contractors



”

What normally would take many hours to change in an off-site welding bay, my team can do on site in minutes using the Framo 80 system

“It's as easy as
Meccano!”

Project Manager, Mercury Engineering

Sikla Framo

Beam Section TP

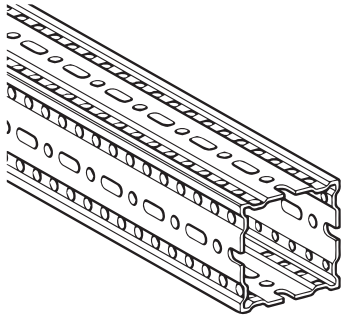

CODE	Description	Dimensions
F 80		
192539	Beam Section TP F 80 (6m)	80 x 80 x 3
F100		
112904	Beam Section TP F 100 (6m)	100 x 100 x 4

Self Forming Screw FLS

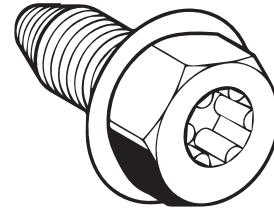

CODE	Description	Fixing
F 80 + F100		
192512	FLS F80 Self Forming Screw	M10

End Cap ADK

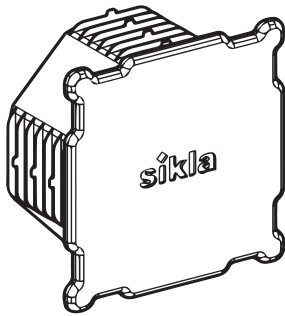

CODE	Description	Dimensions
F 80		
192674	End Cap ADK F 80	80 x 80
F 100		
113086	End Cap ADK F 100	100 x 100

End Support STA

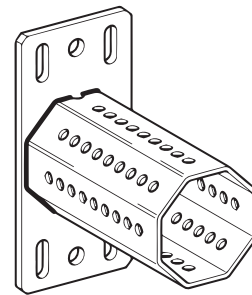

CODE	Description	Plate Dimensions	Fixing
F 80			
192856	STA F80	190 x 80 x 8	M10
F 100			
113023	STA F 100	200 x 100 x 8	M10

Sikla Framo

End Support STA E

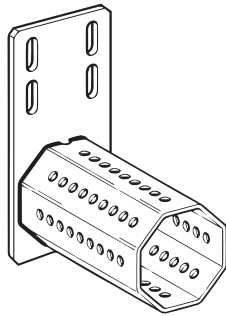

CODE	Description	Plate Dimensions	Fixing
F 80			
192863	STA F 80-E	165 x 80 x 8	M10
F 100			
113074	STA F100-E	185 x 100 x 8	M10

End Support WBD

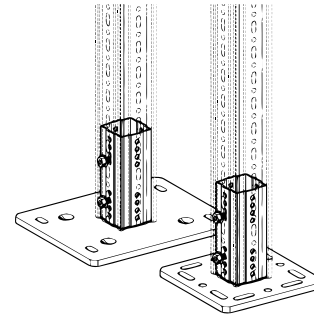

CODE	Description	Base Plate Dimensions	Fixing
F 80			
192801	End Support WBD F 80-80/120	220 x 220 x 12	M12
192818	End Support WBD F 80-121/160	320 x 260 x 12	M12
192825	WBD F 80-161/200	320 x 310 x 12	M16
192832	WBD F 80-201/300	420 x 220 x 12	M16
192849	WBD F 80-T Footplate	220 x 220 x 12	M12
F 100			
113075	End Support WBD F 100-80/120	220 x 220 x 12	M12
113076	End Support WBD F 100-121/160	320 x 260 x 12	M12
113077	End Support WBD F 100-161/200	320 x 310 x 12	M16
113078	WBD F 100-201/300	420 x 220 x 12	M16
113079	WBD F 100-T Footplate	220 x 220 x 12	M12

Insulated Foot Plate SHB F 80

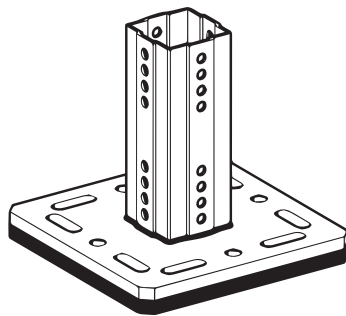

CODE	Description	Base Plate Dimensions
198926	Insulated Foot Plate SHB F 80	220 x 220 x 12

Sikla Framo

Cantilever Bracket AK

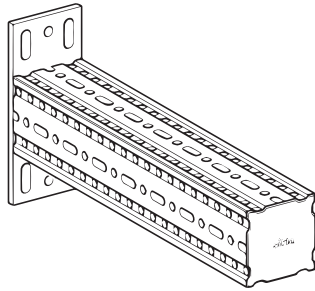

CODE	Description	Base Plate Dimensions	Fixing
F 80			
192764	AK F 80-400mm Cantilever Bracket	190 x 90 x 8	M10
192771	AK F100-800mm Cantilever Bracket	190 x 80 x 8	M10
F 100			
113068	AK F 80-400mm Cantilever Bracket	210 x 100 x 8	M10
113069	AK F100-800mm Cantilever Bracket	210 x 100 x 8	M10

Beam Bracket TKO

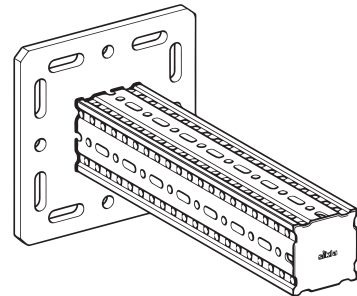

CODE	Description	Base Plate Dimensions	Fixing
F 80			
192788	TKO F 80-400mm Beam Bracket	220 x 220 x 12	M12
192795	TKO F 80-800mm Beam Bracket	220 x 220 x 12	M12
F 100			
113071	TKO F 100-400mm Beam Bracket	220 x 220 x 12	M12
113072	TKO F 100-400mm Beam Bracket	220 x 220 x 12	M12

41/41 Channel Adapter SA

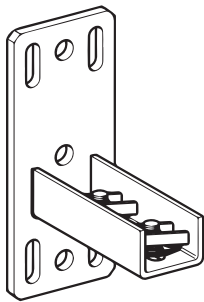

CODE	Description	Base Plate Dimensions	Fixing
F 80			
192887	41/41 Channel Adapter SA F 80	190 x 80 x 8	M10
F 100			
113081	41/41 Channel Adapter SA F 100	210 x 100 x 8	M10

Assembly Set MS 5P

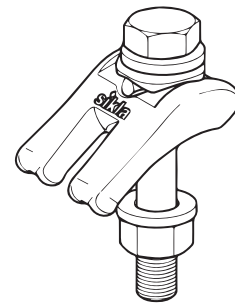

CODE	Description	Fixing
F 80 & F 100		
115843	Assembly Set MS 5P M12	M12
115844	Assembly Set MS 5P M16	M16

Sikla Framo

U-Holder SB

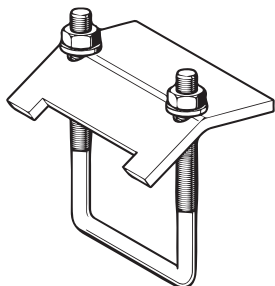

CODE	Description	Fixing
F 80		
192683	U-Holder SB F 80-16	M10
194010	U-Holder SB F 80-40	M12
F100		
113082	U-Holder SB F 100-16	M10
113083	U-Holder SB F 100-40	M12

Mounting Plate GPL F

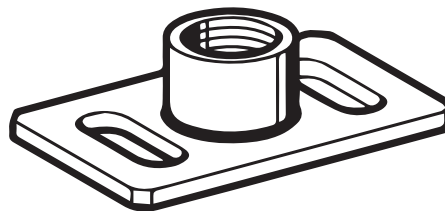

CODE	Description	Base Plate Dimensions	Fixing
F 80			
113004	GPL F 80-½"	80 x 50 x 4	M10
112911	GPL F 80-M10	80 x 50 x 4	M10
195833	GPL F 80-M12	80 x 50 x 4	M10
192900	GPL F 80-M16	80 x 50 x 4	M10
F100			
113084	GPL F 100-½"	100 x 50 x 4	M10
113646	GPL F 100-M10	100 x 50 x 4	M10
113090	GPL F 100-M12	100 x 50 x 4	M10
113089	GPL F 100-M16	100 x 50 x 4	M10

Beam Section Holder TPH

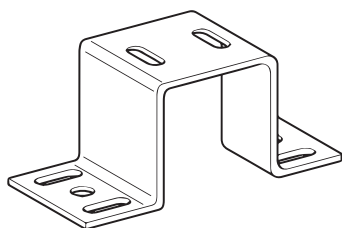

CODE	Description	Fixing
F 80		
195765	Beam Section Holder TPH F 80	M10
F100		
113084	Beam Section Holder TPH F 100	M10

www.shawston.co.uk

Shawston London
Units 8 & 9,
Hillbottom Road,
Sands Industrial Estate,
High Wycombe,
Bucks HP12 4HS

Tel: 01494 460 910
Fax: 01494 522 573
Email: London@shawston.co.uk

Shawston Birmingham
Bay 1, Block D,
The Bescot Estate,
Woden Road West, Wednesbury
West Midlands WS10 7SG

Tel: 0121 556 3400
Fax: 0121 506 4669
Email: Birmingham@shawston.co.uk

Shawston Manchester
Great Norbury Street,
Hyde,
Cheshire SK14 1BW

Tel: 0161 368 4545
Fax: 0161 367 8114
Email: Manchester@shawston.co.uk

Shawston Glasgow
Block 1 Unit 4,
Annick Industrial Estate,
31 Sandilands Street,
Shettleston,
Glasgow G32 OHT

Tel: 0141 778 6975
Fax: 0141 778 6264
Email: Glasgow@shawston.co.uk
